

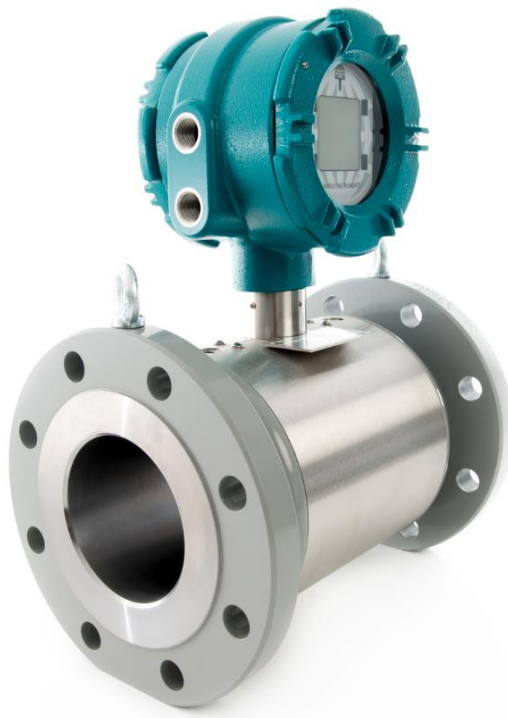

TRANSUS INSTRUMENTS B.V.  
Bloesemlaan 4, 3897LN, Zeewolde  
The Netherlands  
[infol@transus-instruments.com](mailto:infol@transus-instruments.com)  
[www.transus-instruments.com](http://www.transus-instruments.com)

DOCUMENT TITLE  
SAFETY INSTRUCTIONS UIM SERIES FLOWMETER



## Safety Instructions UIM Series Flowmeter

DOCUMENT UIM SERIES SAFETY INSTRUCTIONS	REVISION 2.2	REVISION DATE 28-JAN-2021	PAGE 1 OF 19
--	-----------------	------------------------------	-----------------



TRANSUS INSTRUMENTS B.V.  
Bloesemlaan 4, 3897LN, Zeewolde  
The Netherlands  
[info@transus-instruments.com](mailto:info@transus-instruments.com)  
[www.transus-instruments.com](http://www.transus-instruments.com)

DOCUMENT TITLE  
SAFETY INSTRUCTIONS UIM SERIES FLOWMETER

This reproduction is sole property of Transus Instruments B.V. and is subject to the conditions that it or any information contained therein will not be used in any way detrimental to our interests and that all copies will be returned immediately on demand.

## Table of contents

<b>1</b>	<b>Contents of this document.....</b>	<b>4</b>
1.1	Conventions.....	4
1.2	References.....	4
1.3	Abbreviations.....	4
<b>2</b>	<b>Important information.....</b>	<b>6</b>
2.1	Main hazards.....	6
2.2	Intended use.....	6
2.3	Identification.....	6
2.4	Safety instructions for the operator.....	6
2.5	Specific conditions of use.....	8
2.6	Operation in explosive atmospheres.....	8
2.7	Legislative requirements.....	8
2.8	Interconnection of the UIM Series Flowmeter.....	9
2.8.1	Interconnection to Pressure and Temperature sensors.....	9
2.8.2	Interconnecting the Non intrinsically safe USB port.....	10
2.9	Cleaning.....	10
2.10	Installation, operation and maintenance.....	10
2.11	Additional documentation.....	10
2.12	Marking.....	12
<b>3</b>	<b>Installation and wiring.....</b>	<b>13</b>
3.1	Wiring.....	13
<b>4</b>	<b>Electrical Parameters.....</b>	<b>16</b>
<b>5</b>	<b>Control drawings.....</b>	<b>19</b>



TRANSUS INSTRUMENTS B.V.  
Bloesemlaan 4, 3897LN, Zeewolde  
The Netherlands  
[infol@transus-instruments.com](mailto:infol@transus-instruments.com)  
[www.transus-instruments.com](http://www.transus-instruments.com)

DOCUMENT TITLE  
SAFETY INSTRUCTIONS UIM SERIES FLOWMETER

This reproduction is sole property of Transus Instruments B.V. and is subject to the conditions that it or any information contained therein will not be used in any way detrimental to our interests and that all copies will be returned immediately on demand.

## Introduction

This document provides essential safety information for the installation, of the UIM series ultrasonic gas flowmeter. It contains information for correct installation of this product. It also contains important instructions to prevent accidents and serious damage during installation, commissioning and operation. Before installing the product read and understand this document. Strictly follow the safety instructions and warnings.

In the event of questions or need for additional information regarding specific matters about the UIM Series, please contact Transus Instruments via email or telephone.

These safety instructions are based on the latest information at the time of writing. It is provided subject to changes and updates. We reserve the right to change the configuration and/or construction of our products at any time without obligation to update previously shipped products.

The warranty provisions stipulated in our Terms and Conditions are applicable to the product. The manufacturer shall have no obligation in the event that:

- Repair or replacement of equipment or parts has been required through normal wear and tear, or by necessity in whole or part by catastrophe, or the fault or negligence of the purchaser;
- The equipment, or parts, have been maintained or repaired by other than an authorized representative of the manufacturer, or have been modified in any manner without prior express written permission of the manufacturer;
- Non-original parts are used;
- Equipment is used improperly, incorrectly, carelessly or not in line with its nature and/or purpose;
- Use of this product with unauthorized equipment or peripherals, including, but not necessarily limited to, cables, testing equipment, computers, voltage, etc.

Transus Instruments is not responsible for the incidental or consequential damages resulting from the breach of any express or implied warranties, including damage to property, and to the extent permitted by law, damage for personal injury.

DOCUMENT UIM SERIES SAFETY INSTRUCTIONS	REVISION 2.2	REVISION DATE 28-JAN-2021	PAGE 3 OF 19
--	-----------------	------------------------------	-----------------

## 1 Contents of this document

This manual contains several sections, covering various aspects for proper installation and operation of the UIM series flowmeter.

Chapter 1	This chapter
Chapter 2	Installation
Chapter 3	safety instructions
Chapter 4	Electrical parameters
Chapter 5	Control drawings

### 1.1 Conventions

The following symbol and indication conventions are used throughout this manual.



#### *Warning!*

A warning indicates hazards or unsafe practices that could result in severe personal injury or death.



#### *Attention!*

This sign indicates potential hazardous or unsafe operations that could result in minor personal injury or damage of product or property. It is also used to indicate operations or practices that could cause the product to operate in an unexpected way or provide results that are outside the specification limits



#### *Specific information for explosion safety*

This sign is used where specific important information is given in order to comply with explosion safety regulations

### 1.2 References

### 1.3 Abbreviations

The following abbreviations are used throughout the document:



TRANSUS INSTRUMENTS B.V.  
Bloesemlaan 4, 3897LN, Zeewolde  
The Netherlands  
[infol@transus-instruments.com](mailto:infol@transus-instruments.com)  
[www.transus-instruments.com](http://www.transus-instruments.com)

DOCUMENT TITLE  
SAFETY INSTRUCTIONS UIM SERIES FLOWMETER

This reproduction is sole property of Transus Instruments B.V. and is subject to the conditions that it or any information contained therein will not be used in any way detrimental to our interests and that all copies will be returned immediately on demand.

ATEX	ATmosphère Explosive
EMC	Electromagnetic Compatibility
IEC	International Electrotechnical Commission
IECEX	International Electro technical Commission certification scheme for Explosive atmospheres
IS	Intrinsic Safety
ISO	International Organization for Standardization
LVD	Low Voltage Directive
OIML	Organisation Internationale de Métrologie Légale
PCBA	Printed Circuit Board Assembly
QPS	QPS Evaluation Services
SPU	Signal Processing Unit (the electronics of the flowmeter)
USM	Ultrasonic FlowMeter

## 2 Important information

### 2.1 Main hazards



#### *Warning!*

Natural gas flows through the meterbody of the UIM series ultrasonic gas flowmeter. Do not remove any transducers or parts from the meterbody whilst the flowmeter is under pressure. potentially explosive gas can escape and parts can blow out.

### 2.2 Intended use

The UIM series ultrasonic gas flowmeter primary use is to measure the volume flow rate and gas velocity of gases in pipelines.

The UIM series flowmeters are suitable for use in pressurized lines within the design conditions specified on the flowmeter nameplate.



#### *Warning!*

It is not allowed to operate the UIM Series Ultrasonic flowmeter outside its design pressure and temperature limits. Refer to the nameplate on the device for the minimum and maximum limits.

When using the UIM Series flowmeter in outdoor conditions where ice and snow could build up on the flowmeter, the UIM Series flowmeter is considered part of the piping system and sufficient construction is provided to support the UIM Series flowmeter.

### 2.3 Identification

The Ultrasonic flowmeter is available with approval for use in hazardous area according to ATEX, IECEx or cQPSus certification. Always refer to the actual label information on your flowmeter for the specific approval of your flowmeter and this manual for correct use.

Each SPU label comprises:

- Our company name and address
- Type of Ultrasonic flowmeter
- Hazardous area approval
- Model identification of the SPU
- Serial number of the SPU
- Power requirements of the SPU
- Year-Month
- Warning: Read instruction manual before operating device
- Reference to Control drawing (INSTALL PER DRAWING 01-0198)

### 2.4 Safety instructions for the operator



These safety instructions are applicable for the UIM Series ultrasonic flowmeter installations in hazardous areas.

The UIM series flowmeter is suitable for use in pressurized lines within the design conditions specified on the flowmeter nameplate.



TRANSUS INSTRUMENTS B.V.  
Bloesemlaan 4, 3897LN, Zeewolde  
The Netherlands  
[info@transus-instruments.com](mailto:info@transus-instruments.com)  
[www.transus-instruments.com](http://www.transus-instruments.com)

DOCUMENT TITLE  
SAFETY INSTRUCTIONS UIM SERIES FLOWMETER

This reproduction is sole property of Transus Instruments B.V. and is subject to the conditions that it or any information contained therein will not be used in any way detrimental to our interests and that all copies will be returned immediately on demand.

Do not install, operate or maintain this flowmeter without reading, understanding and following the operating instructions, otherwise injury or damage may result.

Read and understand these operating instructions carefully before the installation of the equipment and keep them for future reference.

Observe all warnings, notes and instructions as marked on the packaging of the equipment and detailed in the operating instructions.

**WARNING - EXPLOSION HAZARD**, Do not change or alter any components of the flowmeter. Unauthorized changes or substitutions of components may impair the explosion safety of the equipment.

**WARNING - EXPLOSION HAZARD**, The ultrasonic transducers are made out of titanium and contain piezo electric devices. The ignition hazard due to physical impact or friction shall be excluded by adequate provisions. The process piping and flowbody are considered adequate provision.

The special conditions of use as described in the EC type examination certificate must be followed. In addition, all given electrical specifications must be met.

The electrical installation must be in accordance with applicable national standards (equivalent to IEC 364) in addition to the requirements for installation in hazardous areas according to EN/IEC 60079-14 "Electrical installations in hazardous locations" or equivalent national standards.

Installation, operation, service and maintenance of the equipment must only be performed by authorised and trained personnel with the necessary knowledge and qualifications in explosion safety.

If the product does not operate normally, please refer to the service and troubleshooting instructions, or contact Transus Instruments for help.

To prevent water entering the Electronics enclosure, firmly tighten the covers when closing. Make sure the O-rings on the covers are correctly fitted and in good condition.

Take care that no dirt / particles are present on the thread or O-rings before closing the covers

## 2.5 Specific conditions of use

The following conditions as defined in the explosion safety certificates shall be considered before operating the device.

- The transducers must be installed in an enclosure that protects the front face of the transducers against impact. This additional enclosure may be the process pipe.
- For Flowmeter electronic enclosures made of aluminium only:  
 If it is mounted in an area where the use of EPL Ga equipment is required, it must be installed such, that, even in the event of rare incidents, ignition sources due to impact and friction sparks are excluded.
- Precautions shall be taken to minimize the risk from electrostatic discharge of painted parts.
- The UIM Series flowmeter may be used for applications with process temperatures above 80°C when installing the SPU (electronics enclosure) remote from the process pipe. The maximum temperature process temperature for each temperature class shall be limited as per table below.

Temp class	Max surface temp	Max Process temp
T1	450 °C	445
T2	300 °C	295
T3	200 °C	195
T4	135 °C	130



### *Attention!*

REFER TO DRAWING 06\_0009 for remote electronics installation requirements

## 2.6 Operation in explosive atmospheres

The UIM series Flowmeter is suitable for use in potentially explosive atmospheres. It is designed to be installed in explosion proof areas classified as Gases, vapours and mists, Zone 0. The equipment protection level (EPL) is Ga. For North America and Canada the product is suitable for Class 1, Division 1, Gas groups A thru D.

- ATEX / IECEx                      Ex II 1 G Ex ia IIC T4 Ga
- US / Canada                        Class 1, Division 1, Groups A, B, C, D T4, Class I Zone 0, AEx ia IIC T4 Ga

## 2.7 Legislative requirements

### CE Marking

The flowmeter is designed to meet the safety requirements in accordance with sound engineering practice. It has been tested and has left the factory in a condition in which it is safe to operate. The equipment is in conformity with the statutory requirements of the EC directive and complies with applicable regulations and standards for electrical safety EN 61010, hazardous area equipment 94/9 EC (ATEX100a) and electromagnetic compatibility EN 61326. A CE Declaration of Conformity has been issued, a copy is available on the website or will be provided on request.

### WEEE Directive



The Waste Electrical and Electronic Equipment Directive (WEEE Directive) aims to minimize the impact of electrical and electronic goods on the environment by increasing re-use and recycling and





by reducing the amount of WEEE going to landfill. It seeks to achieve this by making producers responsible for financing the collection, treatment, and recovery of waste electrical equipment, and by obliging distributors to allow consumers to return their waste equipment free of charge.

Transus Instruments offers its customers the possibility of returning unused and obsolete equipment for correct disposal and recycling. The Dustbin Symbol indicates that when the last user wishes to discard this product, it must be sent to appropriate facilities for recovery and recycling. By not discarding this product along with other household-type waste, the volume of waste sent to incinerators or landfills will be reduced and natural resources will be conserved. Please contact Transus Instruments for more information

### RoHS Directive

All products manufactured by Transus Instruments are compliant with the relevant aspects of the RoHS Directive

## 2.8 Interconnection of the UIM Series Flowmeter

Refer to Drawing 01-0198 (Control drawing ATEX/IECEX) for electrical parameters

### 2.8.1 Interconnection to Pressure and Temperature sensors

The UIM Series Flowmeters, when fitted with the P/T Option Board is designed to operate with bridge type pressure sensors and platinum RTD temperature sensors.

Approved pressure sensors are given in the table below. These sensors consist of resistive sensing elements only and do not have any active conditioning or amplification circuit. The surface area also exceeds 20mm<sup>2</sup> by a large margin.

Series	Manufacturer	Approved Part Numbers	Comment
US300	Measurement Specialties	US32x-00000x-xxxxx	x - do not care
Pi600	Applied Measurements Ltd	Pi607 Pi610	
Passive Transmitter TM	STS Sensors	any (passive)	
Series 11	Keller AG	any (passive)	
Series 6	Keller AG	any (passive)	
110S	BCM Sensor	Any (passive)	
SP2-2/TPR-2	Wika	any	

Table 2-1: Approved Pressure Sensors

Suitable temperature sensors include 100Ω, 5000Ω and 1000Ω platinum RTDs in two, three or four wire configurations. The RTDs must be mounted in a metal sheath of a minimum 3mm diameter and 10mm length, giving a surface area exceeding 100mm<sup>2</sup>. All temperature sensors meeting these requirements are approved to be used with the UIM Series Flowmeter.

Below figure shows the interconnection details to the passive pressure and temperature sensors.

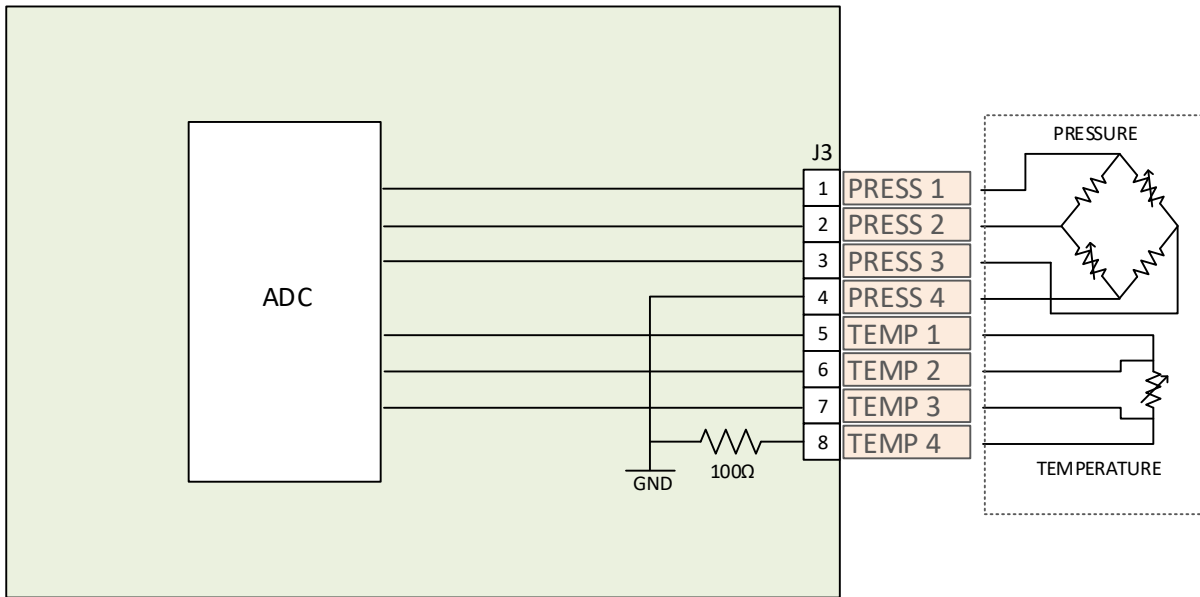

**Warning!**

ONLY INTERCONNECT APPROVED PRESSURE AND TEMPERATURE SENSORS.  
 MAXIMUM CABLE LENGTH TO THE SENSORS MAY NOT EXCEED 3 meters (6.7 ft)

**2.8.2 Interconnecting the Non intrinsically safe USB port**

The local USB port can be used to connect non intrinsically safe devices (such as a laptop) to the UIM Series flowmeter. The UIM Series flowmeter's USB circuit has built-in protection to safely connect non intrinsic safe equipment with  $U_m = 250 \text{ VAC}$ .



**Warning!**

ONLY CONNECT THE USB INTERFACE IN SAFE AREA OR ENSURE NO EXPLOSIVE ATMOSPHERE IS PRESENT.  
 MAXIMUM VOLTAGE RATING  $U_m = 250 \text{ VAC}$

**2.9 Cleaning**

Only clean the UIM series ultrasonic flowmeter with a damp cloth. Do not use solvents for cleaning.

**2.10 Installation, operation and maintenance**

More detailed information about installation, operation and maintenance of your UIM Series flowmeter can be found in document TI2\_UIM\_GEN6 - Installation, operation and maintenance manual.

**2.11 Additional documentation**

Additional documentation is delivered with the product. This contains specific set-up data for the individual flowmeter. Depending on the configuration the following documentation is delivered with the meter.

- Certificate of conformity / EX certificates

DOCUMENT UIM SERIES SAFETY INSTRUCTIONS	REVISION 2.2	REVISION DATE 28-JAN-2021	PAGE 10 OF 19
--	-----------------	------------------------------	------------------



TRANSUS INSTRUMENTS B.V.  
Bloesemlaan 4, 3897LN, Zeewolde  
The Netherlands  
[infol@transus-instruments.com](mailto:infol@transus-instruments.com)  
[www.transus-instruments.com](http://www.transus-instruments.com)

DOCUMENT TITLE  
SAFETY INSTRUCTIONS UIM SERIES FLOWMETER

This reproduction is sole property of Transus Instruments B.V. and is subject to the conditions that it or any information contained therein will not be used in any way detrimental to our interests and that all copies will be returned immediately on demand.

- Material certificates
- Meter configuration sheet
- Factory acceptance test report

Furthermore, product information such as this manual can be downloaded from the website

DOCUMENT UIM SERIES SAFETY INSTRUCTIONS	REVISION 2.2	REVISION DATE 28-JAN-2021	PAGE 11 OF 19
--	-----------------	------------------------------	------------------

DOCUMENT NAME T12\_UIM\_GEN7\_SAFETY\_INSTRUCTIONS.DOCX













TRANSUS INSTRUMENTS B.V.  
 Bloesemlaan 4, 3897LN, Zeewolde  
 The Netherlands  
[infoln@transus-instruments.com](mailto:infoln@transus-instruments.com)  
[www.transus-instruments.com](http://www.transus-instruments.com)

DOCUMENT TITLE  
 SAFETY INSTRUCTIONS UIM SERIES FLOWMETER

This reproduction is sole property of Transus Instruments B.V. and is subject to the conditions that it or any information contained therein will not be used in any way detrimental to our interests and that all copies will be returned immediately on demand.

## 2.12 Marking

The SPU has a permanently affixed stainless-steel label with relevant explosion safety information engraved, examples are shown below.

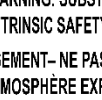
Certification	Marking
ATEX	<div style="display: flex; justify-content: space-between;"> <div style="width: 30%;">  <p>Transus Instruments B.V.            Bloesemlaan 4            3897LN Zeewolde            The Netherlands</p>  </div> <div style="width: 30%; border: 1px solid black; padding: 5px;">  <p>SUBSTITUTION OF COMPONENTS MAY IMPAIR INTRINSIC SAFETY            INSTALL PER DRAWING 01_0198</p> </div> <div style="width: 30%; border: 1px solid black; padding: 5px;"> <p style="text-align: center; font-size: 24pt;"><b>UIM Series Flowmeter</b></p> </div> </div> <div style="display: flex; justify-content: space-between; margin-top: 10px;"> <div style="width: 30%; border: 1px solid black; padding: 5px;"> <p style="font-size: 24pt; margin: 0;"><b>CE 0344</b></p> <p style="font-size: 18pt; margin: 0;"><b>Ex</b> II 1 G Ex ia IIC T4 Ga            -40°C ≤ Tamb ≤ +60°C            DEKRA 16ATEX0014 X</p> </div> <div style="width: 30%; border: 1px solid black; padding: 5px;"> <p style="text-align: center; font-size: 18pt;">Specific model, serial no and year of manufacture Information            - not relevant for safety -</p> </div> </div>
IECEX	<div style="display: flex; justify-content: space-between;"> <div style="width: 30%;">  <p>Transus Instruments B.V.            Bloesemlaan 4            3897LN Zeewolde            The Netherlands</p>  </div> <div style="width: 30%; border: 1px solid black; padding: 5px;">  <p>SUBSTITUTION OF COMPONENTS MAY IMPAIR INTRINSIC SAFETY            INSTALL PER DRAWING 01_0198</p> </div> <div style="width: 30%; border: 1px solid black; padding: 5px;"> <p style="text-align: center; font-size: 18pt;"><b>UIM Series Flowmeter</b></p> </div> </div> <div style="display: flex; justify-content: space-between; margin-top: 10px;"> <div style="width: 30%; border: 1px solid black; padding: 5px;"> <p style="font-size: 18pt; margin: 0;"><b>Ex ia IIC T4 Ga</b>            -40°C ≤ Tamb ≤ +60°C            IECEX DEK16.0007X</p> </div> <div style="width: 30%; border: 1px solid black; padding: 5px;"> <p style="text-align: center; font-size: 18pt;">Specific model, serial no and year of manufacture Information            - not relevant for safety -</p> </div> </div>
ATEX/IECEX	<div style="display: flex; justify-content: space-between;"> <div style="width: 30%;">  <p>Transus Instruments B.V.            Bloesemlaan 4            Zeewolde            The Netherlands</p>  </div> <div style="width: 30%; border: 1px solid black; padding: 5px;">  <p>SUBSTITUTION OF COMPONENTS MAY IMPAIR INTRINSIC SAFETY INSTALL PER DRAWING 01_0198</p> </div> <div style="width: 30%; border: 1px solid black; padding: 5px;"> <p style="text-align: center; font-size: 18pt;"><b>UIM Series Flowmeter</b></p> </div> </div> <div style="display: flex; justify-content: space-between; margin-top: 10px;"> <div style="width: 30%; border: 1px solid black; padding: 5px;"> <p style="font-size: 18pt; margin: 0;"><b>Ex ia IIC T4 Ga</b>            -40°C ≤ Tamb ≤ +60°C            IECEX DEK16.0007X</p> </div> <div style="width: 30%; border: 1px solid black; padding: 5px;"> <p style="font-size: 24pt; margin: 0;"><b>CE 0344</b></p> <p style="font-size: 18pt; margin: 0;"><b>Ex</b> II 1 G Ex ia IIC T4 Ga            -40°C ≤ Tamb ≤ +60°C            DEKRA 16ATEX0014 X</p> </div> </div>
cQPSus	<div style="display: flex; justify-content: space-between;"> <div style="width: 30%;">  <p>Transus Instruments B.V.            Bloesemlaan 4, 3897LN            Zeewolde, The Netherlands</p>  </div> <div style="width: 30%; border: 1px solid black; padding: 5px;">  <p>WARNING: SUBSTITUTION OF COMPONENTS MAY IMPAIR INTRINSIC SAFETY INSTALL PER DRAWING 06_0010            AVERTISSEMENT- NE PAS REMPLACER LES ACCUMULATEURS SI UNE ATMOSPHERE EXPLOSIVE PEUT ÊTRE PRÉSENTE            INSTALLER PAR DOCUMENT 06_0010</p> </div> <div style="width: 30%; border: 1px solid black; padding: 5px;"> <p style="text-align: center; font-size: 18pt;"><b>UIM Series Flowmeter</b></p> <div style="border: 1px solid black; width: 100%; height: 100%; margin-top: 10px;"></div> </div> </div> <div style="display: flex; justify-content: space-between; margin-top: 10px;"> <div style="width: 30%; border: 1px solid black; padding: 5px;"> <p style="font-size: 18pt; margin: 0;"><b>PS</b>  <small>US CERTIFIED</small></p> <p style="font-size: 12pt; margin: 0;">Class I Division 1 GR ABCD T4            Ex ia IIC T4 Ga            Class I Zone 0, AEx ia IIC T4 Ga</p> </div> </div>



TRANSUS INSTRUMENTS B.V.  
 Bloesemlaan 4, 3897LN, Zeewolde  
 The Netherlands  
[info@transus-instruments.com](mailto:info@transus-instruments.com)  
[www.transus-instruments.com](http://www.transus-instruments.com)

DOCUMENT TITLE  
**SAFETY INSTRUCTIONS UIM SERIES FLOWMETER**

This reproduction is sole property of Transus Instruments B.V. and is subject to the conditions that it or any information contained therein will not be used in any way detrimental to our interests and that all copies will be returned immediately on demand.

### 3 Installation and wiring

The UIM Series flowmeter can be equipped with a variety of option boards. Make sure to identify which option board is installed in your specific flowmeter. The option boards can be identified by the electronics assembly part number label on the SPU permanently affixed stainless-steel label – refer to below figure for an example.

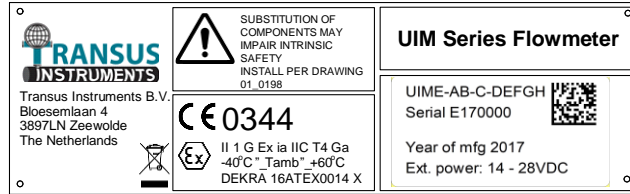

UIM Electronics assembly model number		
UIME-AB-C-DEFGH		
A	x	Number of paths (1 to 4)
B	x	Application type
C	x	Meter size
D - SLOT 1	0	Not installed
	1	RS485 Option board (01-0020)
	2	RS485 IO 4..20mA option board (01-0202)
	3	Dual RS485 IO option board (01-0251)
E - SLOT 2	0	Not installed
	1	P/T option board (01-0022)
	2	4..20mA HART option board (01-0203)
	3	Dual RS485 IO option board (01-0251)
F - LCD	0	Not installed
	1	Installed
	2	SS316 enclosure with display/keypad
G	1	M20 cable gland entries
	2	1/2" NPT cable gland entries
H	x	Options, not affecting explosion safety

#### 3.1 Wiring

User connections are available in the back compartment of the SPU. The transducers and optional pressure and temperature sensors are already factory connected when applicable. For detailed interconnecting instructions and electrical parameters also refer to Control Drawing 01-0198.

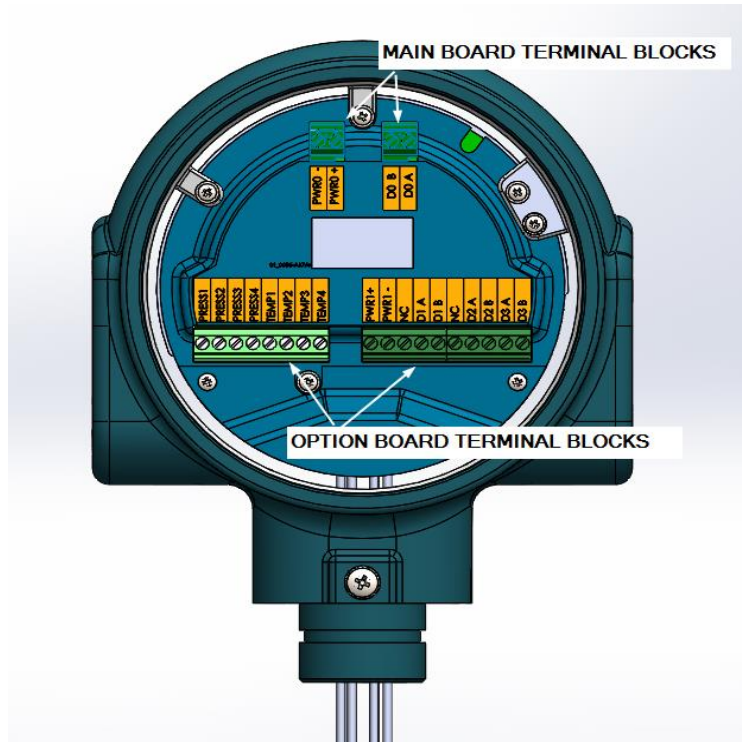

Figure 3-1 - User connections shown with PT option board (left) and IO option board (right)

The electronics enclosure is provided with four M20 or ½” NPT size cable gland entries available to the user. Select and install the glands according to all applicable requirements, like those stated in:

- National and local regulations;
- The UIM Series flowmeter documentation and on the SPU label
- the control drawing
- the specifications of the user wiring.

It is recommended to use suitable armoured shielded cable to provide protection against mechanical damage and electrical interference.

Important: Only use cables with suitable, capacitance, inductance, resistance, diameter, cores and length compliant with the Electrical parameters of the flowmeter.

If your UIM series flowmeter is cQPSus certified (refer to the SPU label), the following special remarks are also applicable:

- Installations shall comply with the relevant requirements of the latest edition of the National Electrical Code (ANSI/NFPA 70). Installations shall comply with the latest edition the manufacturer’s instruction manual.
- For intrinsically safe installation in the United States of America, electrical equipment connected to the Associated Apparatus shall not use or generate more than 250 volts rms.
- For guidance on United States of America installations, see ANSI/ISA-RP12.06.01, Installation of Intrinsically Safe Systems for Hazardous (Classified) Locations.
- Tampering and replacement with non-factory components may adversely affect the safe use of the system.
- Read and understand the instruction manual before operating the device.



TRANSUS INSTRUMENTS B.V.  
Bloesemlaan 4, 3897LN, Zeewolde  
The Netherlands  
[infol@transus-instruments.com](mailto:infol@transus-instruments.com)  
[www.transus-instruments.com](http://www.transus-instruments.com)

DOCUMENT TITLE  
SAFETY INSTRUCTIONS UIM SERIES FLOWMETER

This reproduction is sole property of Transus Instruments B.V. and is subject to the conditions that it or any information contained therein will not be used in any way detrimental to our interests and that all copies will be returned immediately on demand.

- Each cable gland or blind plug fitted in the enclosure must comply with the NEMA or IP class and the temperatures indicated on the SPU (e.g. by using a suitable IP washer).
- During transport and storage the electronics enclosure may contain a bag of silica gel to absorb excessive humidity. Remove the bags before powering the SPU



***Warning!***

The UIM Series requires an intrinsically safe power supply compatible with the electrical parameters stated in chapter 4.



## 4 Electrical Parameters

### 01-0018 (TIP005) Mainboard

#### Power

PWR-, PWR+

Main board Power supply

In type of protection intrinsic safety, with the following maximum values:

U <sub>i</sub>	= 29 V
P <sub>i</sub>	= 670 mW
I <sub>i</sub>	= 100 mA
L <sub>i</sub>	= 0.3 mH
C <sub>i</sub>	= 0.03 μF

#### Frequency output

D0A, D0B

Frequency / pulse output

In type of protection intrinsic safety, with the following maximum values:

U <sub>i</sub>	= 29V
P <sub>i</sub>	= 670 mW
I <sub>i</sub>	= 100 mA
L <sub>i</sub>	= 0.15 mH
C <sub>i</sub>	= 0.03 μF

### 01-0020 (TIP007) RS485 Option board parameters

#### Power

PWR1+, PWR1-

External power to the I/O option board

In type of protection intrinsic safety, with the following maximum values:

U <sub>i</sub>	= 28V
P <sub>i</sub>	= 670 mW
I <sub>i</sub>	= 100mA
L <sub>i</sub>	= 0.3mH
C <sub>i</sub>	= 0.03uF

#### RS485 port

D1A, D1B

Differential RS485 two wire communications port

In type of protection intrinsic safety, with the following maximum values:

U <sub>o</sub>	= 4.12V	U <sub>i</sub>	= 4.2V
P <sub>o</sub>	= 670 mW	P <sub>i</sub>	= 250mW
I <sub>o</sub>	= 150mA	I <sub>i</sub>	= 250mA
C <sub>i</sub>	= 20uF		
L <sub>i</sub>	= negligible		

#### Digital output

D2A, D2B

Passive optically isolated open collector output

In type of protection intrinsic safety, with the following maximum values:

U <sub>i</sub>	= 15V
P <sub>i</sub>	= 250 mW
I <sub>i</sub>	= 100mA
C <sub>i</sub>	= 0.03uF
L <sub>i</sub>	= 0.02mH

#### Digital output

D3A, D3B

Passive optically isolated open collector output

In type of protection intrinsic safety, with the following maximum values:

U <sub>i</sub>	= 15V
P <sub>i</sub>	= 250 mW
I <sub>i</sub>	= 100mA
C <sub>i</sub>	= 0.03uF
L <sub>i</sub>	= 0.02mH





**01-0202 (TIP010) RS485 IO 4..20mA Option board parameters**

**Power / 4..20mA Loop**

4..20mA Loop / Option board supply

PWR1+, PWR1-

In type of protection intrinsic safety, with the following maximum values:

- Ui = 29V
- Pi = 670 mW
- li = 100mA
- Li = 0.3mH
- Ci = 0.03uF

**RS485 port**

Differential RS485 two wire communications port

D1A, D1B

In type of protection intrinsic safety, with the following maximum values:

- Uo = 4.12V
- Po = 670 mW
- lo = 150mA
- Ci = 20uF
- Li = negligible
- Ui = 4.2V
- Pi = 250mW
- li = 250mA

**Digital output**

Passive optically isolated open collector output

D2A, D2B

In type of protection intrinsic safety, with the following maximum values:

- Ui = 15.5V
- Pi = 250 mW
- li = 100mA
- Ci = 0.03uF
- Li = 0.02mH

**Digital output**

Passive optically isolated open collector output

D3A, D3B

In type of protection intrinsic safety, with the following maximum values:

- Ui = 15.5V
- Pi = 250 mW
- li = 100mA
- Ci = 0.03uF
- Li = 0.02mH

**01-0203 (TIP011) 4..20mA HART Option board parameters**

**Loop Power / 4..20mA**

4..20mA Loop power

LPWR2+, LPWR2-

In type of protection intrinsic safety, with the following maximum values:

- Ui = 29V
- Pi = 670 mW
- li = 100mA
- Li = 0.3mH
- Ci = 0.03uF



TRANSUS INSTRUMENTS B.V.  
Bloesemlaan 4, 3897LN, Zeewolde  
The Netherlands  
[info@transus-instruments.com](mailto:info@transus-instruments.com)  
[www.transus-instruments.com](http://www.transus-instruments.com)

DOCUMENT TITLE  
SAFETY INSTRUCTIONS UIM SERIES FLOWMETER

This reproduction is sole property of Transus Instruments B.V. and is subject to the conditions that it or any information contained therein will not be used in any way detrimental to our interests and that all copies will be returned immediately on demand.

#### 01-0251 (TIP014) Dual RS485 Option board parameters

##### Power / 4..20mA Loop

PWR1+, PWR1-

4..20mA Loop / Option board supply

In type of protection intrinsic safety, with the following maximum values:

U<sub>i</sub> = 29V  
P<sub>i</sub> = 670 mW  
I<sub>i</sub> = 100mA  
L<sub>i</sub> = 0.3mH  
C<sub>i</sub> = 0.03uF

##### RS485 port

D1A, D1B

Differential RS485 two wire communications port

In type of protection intrinsic safety, with the following maximum values:

U<sub>o</sub> = 4.12V                      U<sub>i</sub> = 4.2V  
P<sub>o</sub> = 670 mW                  P<sub>i</sub> = 250mW  
I<sub>o</sub> = 150mA                    I<sub>i</sub> = 250mA  
C<sub>i</sub> = 20uF  
L<sub>i</sub> = negligible

##### Digital output

D2A, D2B

Passive optically isolated open collector output

In type of protection intrinsic safety, with the following maximum values:

U<sub>i</sub> = 15V  
P<sub>i</sub> = 250 mW  
I<sub>i</sub> = 100mA  
C<sub>i</sub> = 0.03uF  
L<sub>i</sub> = 0.02mH

##### Digital output

D3A, D3B

Passive optically isolated open collector output

In type of protection intrinsic safety, with the following maximum values:

U<sub>i</sub> = 15V  
P<sub>i</sub> = 250 mW  
I<sub>i</sub> = 100mA  
C<sub>i</sub> = 0.03uF  
L<sub>i</sub> = 0.02mH

##### RS485 port

D4A, D4B

Differential RS485 two wire communications port

In type of protection intrinsic safety, with the following maximum values:

U<sub>o</sub> = 4.12V                      U<sub>i</sub> = 4.2V  
P<sub>o</sub> = 670 mW                  P<sub>i</sub> = 250mW  
I<sub>o</sub> = 150mA                    I<sub>i</sub> = 250mA  
C<sub>i</sub> = 20uF  
L<sub>i</sub> = negligible



TRANSUS INSTRUMENTS B.V.  
Bloesemlaan 4, 3897LN, Zeewolde  
The Netherlands  
[infol@transus-instruments.com](mailto:infol@transus-instruments.com)  
[www.transus-instruments.com](http://www.transus-instruments.com)

DOCUMENT TITLE  
SAFETY INSTRUCTIONS UIM SERIES FLOWMETER

This reproduction is sole property of Transus Instruments B.V. and is subject to the conditions that it or any information contained therein will not be used in any way detrimental to our interests and that all copies will be returned immediately on demand.

## 5 Control drawings

Refer to the following control drawings

- ATEX / IECEX                      Drawing 01-0198                      Control Drawing ATEX/IECEX
- cQPSus                                Drawing 06-0010                      Control drawing cQPSus

DOCUMENT UIM SERIES SAFETY INSTRUCTIONS	REVISION 2.2	REVISION DATE 28-JAN-2021	PAGE 19 OF 19
--	-----------------	------------------------------	------------------